

# CURRENT SENSING (FOR HIGH POWER)

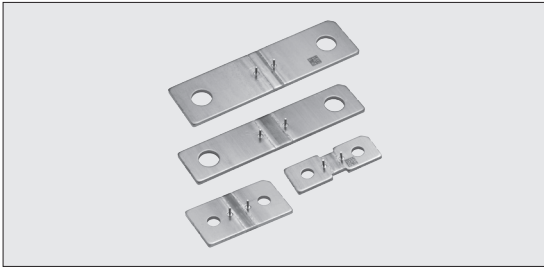

## HS Large Current Shunt

Current Sensing Resistors



### Construction

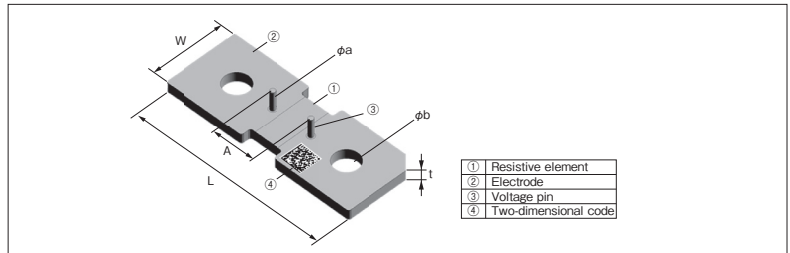

### Features

- Ultra low resistance, suitable for large current sensing.
- Excellent T.C.R. achieved ( $50 \pm 25 \times 10^{-6}/K \sim$ )
- Correct electric current detection by a voltage pin is possible.
- Bus bar and Cable can be screwed on.
- 2D code means individual resistance information.
- Products meet EU-RoHS requirements.
- AEC-Q200 Tested.

### Applications

- Hybrid Electric Vehicle, Electric Vehicle
- BEMS, HEMS

### Reference Standards

IEC 60115-1  
JIS C 5201-1

### Dimensions

Type	Resistance (Ω)	Dimensions (mm)						Weight (g) (1pcs)
		L±0.25	W±0.25	A±0.2	φa±0.2	φb±0.1	t±0.2	
HSAN2P4022M5	50μ	40.0	22.0	8.5	1.0	5.4	2.0	15
HSAN2P8022M8		80.0	22.0	8.5	1.0	8.3	2.0	30
HSAN2P4015M5	100μ	40.0	15.0	8.5	1.0	5.4	2.0	10
HSBN2P8018M8		80.0	18.0	12.0	1.0	8.3	2.0	25
HSAN2P4015M5	200μ	40.0	15.0	8.5	1.0	5.4	1.0	5

### Type Designation

Example

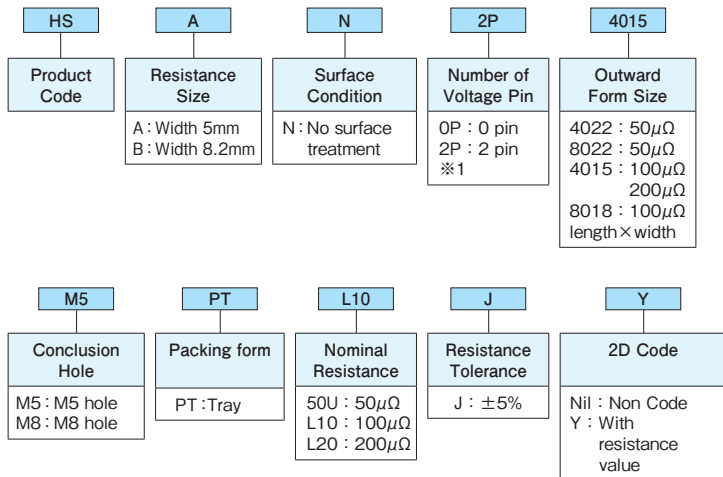

※1 Standard voltage pin: φ 1mm, length 4mm, Sn plating. Contact us for custom type request.  
Contact us when you have control request for environmental hazardous material other than the substance specified by EU-RoHS.

### Ratings

Type	Power Rating <sup>※2</sup> (Current Rating)	T.C.R. ( $\times 10^{-6}/K$ )	Resistance Range (Ω)	Rated Terminal Part Temp.	Operating Temp. Range
HS	50W (1000A)	75±50	50μ	105°C	-65°C~+175°C
	36W (600A)		100μ		
	18W (300A)	50±25	200μ		

※2 A power rating shall be guaranteed with a method shown in the item. (:Performance)

## Derating Curve

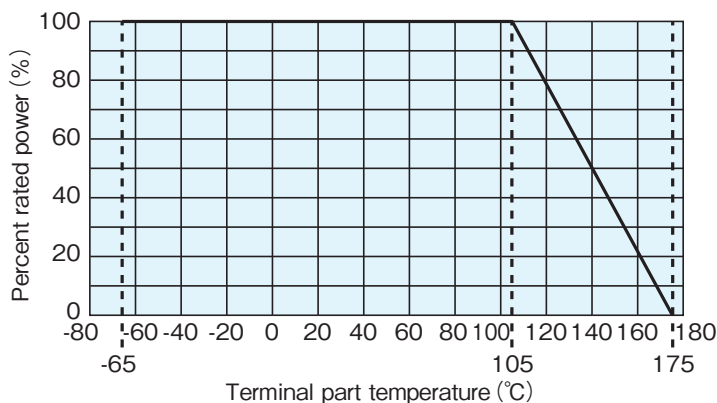

When the terminal part temperature of the resistor exceeds the rated terminal part temperature shown above, the power shall be derated according to the derating curve.

※Please refer to "Introduction of the derating curves based on the terminal part temperature" on the beginning of our catalog before use.

## One-Pulse Limiting Electric Power

The maximum applicable voltage is equal to the max. overload voltage.

Please ask us about the resistance characteristic of continuous applied pulse.

The pulse endurance values are not assured values, so be sure to check the products on actual equipment when you use them.

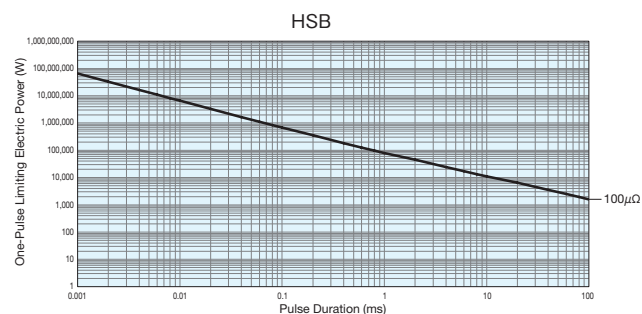
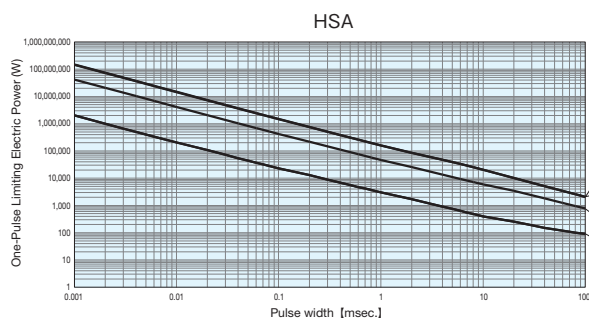

## Thermal Resistance

Resistance (Ω)	Rth (°C/W)
50μ	0.57
100μ	1.2
200μ	2.3

$$R_{th} = (H_s - t_s) / \text{Power}$$

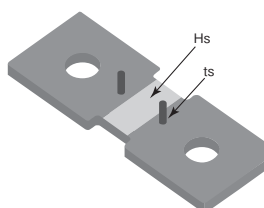

The temperature of the resistor will increase the same  $\Delta T$  from the standard terminal part temperature regardless of the ambient temperature when the same power is applied. This is because there is hardly any heat dissipation from the resistor surface to the ambient air.

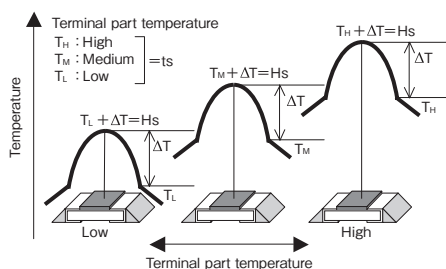

Regarding the temperature rise, the value of the temperature varies per conditions and board for use since the temperature is measured under our measuring conditions. Please refer to us before use.

## Performance

Test Items	Performance Requirements		Test Methods
	$\Delta R \pm \%$	Typical	
Resistance	Within specified tolerance	—	25°C
T.C.R	Within specified T.C.R	—	50μΩ : +25°C/+125°C 100μΩ, 200μΩ : +25°C/+100°C
Rapid change of temperature	0.5	-0.1	-55°C (30min.) / +150°C (30min.) 1000cycles
Endurance at 105°C and less of terminal part temperature	1.0	-0.1	Terminal part temp. : 105°C ± 3°C, 1000h., 1.5h ON/0.5h OFF cycle
Low temperature exposure	0.5	-0.05	-65°C, 1000h.
High temperature exposure	1.0	-0.4	+175°C, 1000h.

## Precautions for Use

- In case of using the low ohm resistors as shunt resistors, please lay out a pattern considering the electromagnetic induction with surrounding inductors.